



MERCEDES FBS4 MANAGER

A black rectangular device, the Mercedes FBS4 Manager, is shown with a coiled black cable. The device has the ABRITES logo and "Diagnostik" printed on its top surface. Two different types of connectors are shown in the foreground: a multi-pin connector on the left and a single-pin connector on the right.

User manual
Version 1.6

Important notes

The Abrites software and hardware products are developed, designed and manufactured by Abrites Ltd. During the production process we comply to all safety and quality regulations and standards, aiming at highest production quality. The Abrites hardware and software products are designed to build a coherent ecosystem, which effectively solves a wide range of vehicle-related tasks, such as:

- Diagnostic scanning;
- Key programming;
- Module replacement,
- ECU programming;
- Configuration and coding.

All software and hardware products by Abrites Ltd. are copyrighted. Permission is granted to copy Abrites software files for your own back-up purposes only. Should you wish to copy this manual or parts of it, you are granted permission only in case it is used with Abrites products, has "Abrites Ltd." written on all copies, and is used for actions that comply to respective local law and regulations.

Warranty

You, as a purchaser of Abrites hardware products, are entitled of a two-year warranty. If the hardware product you have purchased has been properly connected, and used according to its respective instructions, it should function correctly. In case the product does not function as expected, you are able to claim warranty within the stated terms. Abrites Ltd. is entitled to require evidence of the defect or malfunction, upon which the decision to repair or substitute the product shall be made.

There are certain conditions, upon which the warranty cannot be applied. The warranty shall not apply to damages and defects caused by natural disaster, misuse, improper use, unusual use, negligence, failure to observe the instructions for use issued by Abrites, modifications of the device, repair works performed by unauthorized persons. For example, when the damage of the hardware has occurred due to incompatible electricity supply, mechanical or water damage, as well as fire, flood or thunder storm, the warranty does not apply.

Each warranty claim is inspected individually by our team and the decision is based upon thorough case consideration.

Read the full hardware warranty terms on our [website](#).

Copyright information

Copyright:

All material herein is Copyrighted © 2005-2023 Abrites, Ltd.
Abrites software, hardware, and firmware are also copyrighted
Users are given permission to copy any part of this manual provided that the copy is used with Abrites products and the "Copyright © Abrites, Ltd." statement remains on all copies.
"Abrites" is used in this manual as a synonym with "Abrites, Ltd." and all it's affiliates
The "Abrites" logo is a registered trademark of Abrites, Ltd.

Notices:

The information contained in this document is subject to change without prior notice. Abrites shall not be held liable for technical/editorial errors, or omissions herein.
Warranties for Abrites products and services are set forth in the express written warranty statements accompanying the product. Nothing herein should be construed as constituting any additional warranty.
Abrites assumes no responsibility for any damage resulting from the use, misuse, or negligent use of the hardware or any software application.

Safety information

The Abrites products are to be used by trained and experienced users in diagnostics and reprogramming of vehicles and equipment. The user is assumed to have a good understanding of vehicle electronic systems, as well as potential hazards while working around vehicles. There are numerous safety situations that cannot be foreseen, thus we recommend that the user read and follow all safety messages in the available manual, on all equipment they use, including vehicle manuals, as well as internal shop documents and operating procedures.

Some important points:

Block all wheels of the vehicle when testing. Be cautious when working around electricity.

Do not ignore the risk of shock from vehicle and building-level voltages.

Do not smoke, or allow sparks/flame near any part of the vehicle fuel system or batteries.

Always work in an adequately ventilated area, vehicle exhaust fumes should be directed towards the exit of the shop.

Do not use this product where fuel, fuel vapours, or other combustibles could ignite.

In case any technical difficulties occur, please contact the
Abrites Support Team by email at support@abrites.com.

Table of contents

1. Introduction

2. General Information

2.1 Scope of the manual

System requirements:

2.2 Getting Started

3. FBS4 Manager

4. ECU Replacement

4.1 Engine Control Unit (ECU) replacement procedure

4.2 Connections:

4.3 Virginization procedure:

4.3.1 Virginization in the vehicle by OBDII:

4.3.2 Virginization on bench:

4.4 Read FBS4 Personalization Data

4.4.1 Read FBS4 Personalization Data by OBDII

Reading personalization data by OBDII is available for the following units:

4.4.2 Read FBS4 Personalization Data on bench

4.5. ECU BENCH DIAGRAMS:

4.6 MRD1/MRG1 ECUs - CB030 - Mercedes-Benz MD/MG ECU connection cable

4.7 Requirements

4.8 VIN Exchange

5. TCU Replacement

5.1 VGS4 NAG2 7G-Tronic

5.1.1 VGS4-NAG2 Personalization with Previously saved data

5.1.2 VGS4-NAG2 Personalization WITHOUT previously saved data

5.1.3 VGS4-NAG2 Legacy Procedures

Table of contents

- 5.2 VGSNAG3 9G-tronic
 - 5.2.1 VGSNAG3 Personalization with previously saved data
 - 5.2.2 VGSNAG3 Personalization WITHOUT previously saved data
- 5.3 VGS2-DCT Mercedes & VGSNAG2-FDCT
- 5.3.1 Personalization with previously saved data
- 6. DSM replacement**
 - 6.1 Direct Select Module (DSM) replacement procedure
 - 6.1.1 Personalization with previously saved data
 - 6.1.2 DSM Personalization without previously saved FBS data
 - 6.2 Connections
 - 6.3 Legacy procedure for DSM
- 7. ESL (ELV) Repair**
 - 7.1 Connections
 - 7.2 ESL (ELV) diagrams/pinouts for connection on bench.
 - 7.3 Procedure Execution
- 8 More functionalities of the FBS4 Manger**
 - 8.1 ECU Recovery procedure

List of revisions

Date	Chapter	Description	Revision
23.12.2022	ALL	Document created.	1.0
28.03.2023	4 & 5	4 - updated; 5 - created	1.1
21.09.2023	ALL	ECU, TCU, DSM, Quick Start.	1.2
10.11.2023	4.2.1	CB030 information	1.3
20.02.2024	4 & 5	FBS4 unit replacement procedures (MN034)	1.4
22.10.2024	5	VGS4NAG2	1.5
20.08.2025	4, 5, 6, 7	Update on many procedures	1.6

1. Introduction

Congratulations on choosing our wonderful product!

The “Mercedes FBS4 Manager” is an Online server based Abrites software for Mercedes FBS4 vehicles

In order to operate, the software requires you to have an AVDI interface, a Windows based PC with a minimum of 1024MB RAM, 64GB of free hard drive space and at least Windows 7 64bit Service Pack 1 or later version to operate. For optimal operation, it is always recommended to have the latest software version installed, active AMS, and a stable Internet connection.

With the help of this software you can perform DAS module replacement Mercedes FBS4 vehicles.

For proper operation of your diagnostic software you will need a corresponding interface for connection between your PC and vehicle named “AVDI”. “AVDI” stands for “Abrites Vehicle Diagnostic Interface.” It is produced by Abrites Ltd. and intended to act as an interface between the PC and the electronic control units.

Please check the “license viewer” installed on your computer for your unique interface ID number.

The software is in constant development and its functionality is ever growing. The intentions for the Abrites Software are to be used by automotive specialists, but it is simultaneously designed in such a way that is accessible to enthusiasts as well.

AVDI should be used with ABRITES software produced by Abrites Ltd.

ABRITES is a trade mark of Abrites Ltd

2. General Information

2.1 Scope of the manual

This document describes the usage of Abrites Mercedes FBS4 Manager. The document is applicable for the latest software version. In this manual we suppose that the software for your AVDI interface is already installed. Please refer the “AVDI Common User’s Manual” in case it is not.

System requirements:

Minimum system requirements – Windows 10
(Recommended 4GB) and manually updated COM Port driver.

2.2 Getting Started

You can start Abrites Mercedes FBS4 Manager by starting the Abrites Quick Start application and selecting Mercedes icon first.

When the Abrites Diagnostics for Mercedes application is started the main screen of the application will appear where you can select the Mercedes FBS4 Manager.



3. FBS4 Manager

FBS4 Manager is the software that lets you work with DAS modules from the FBS4 platforms. The software is constantly growing and its functionalities will be expanding with future updates. The main screen of the software gives you the unit selection and shows the buttons with the available special functions. You can work with the following modules:

- Electronic Ignition Switch (EVS/EIS)
- Engine Control Unit (ECU)
- Transmission Control Unit (TCU)
- Electronic Steering Lock (ESL)
- Direct Select Module (DSM/DSM222)
- Car Key
- 48V started generators from family INV20EM01 (hybrid vehicles)
- Electric motor 1 & 2

Functionalities:

- **Info** button will provide information about the type of unit and its status
- **Save** button will start reading the FBS data and will let you save it to a file
- **Personalize** button lets you write the FBS data, which you have already saved
- **Virgin** button will set the unit to virgin state. This means the unit will be ready for personalization
- **VIN** button will let you write the VIN to the module
- **Repair** button will start a procedure for Electronic Steering Lock repair



4. ECU Replacement

Engine Control Unit section of the FBS4 Manager has the following functionalities:

- Set FBS4 Electronic Control Modules to virgin state
- Read the personalization data from a FBS4 Control Modules and save it to a file
- Program personalization data from a previously saved file to a FBS4 Control Module
- Personalization without previously saved FBS data
- FBS4 Control Modules Activation
- Display FBS4 status of Control Modules including assembled in hybrid and electric vehicles
- Read/Update configuration data
- Program software versions
- VIN programming

All that lets you do a complete ECU exchange so that the vehicle can start and run properly.

Abrites FBS4 Manager is able to personalize a virgin or new unit in ALL cases.



4.1 Engine Control Unit (ECU) replacement procedure

Engine Control Unit replacement procedure has the following specific steps:

- Reading FBS data
- Virginization
- Personalization

Abrites FBS4 Manager is able to personalize a virgin or new unit in ALL cases.

IMPORTANT! MRD1/MRG1 ECU have a separate procedure for personalization without previously saved data, available a few pages below.

There are 2 general scenarios:

1. Replace the unit when the original unit is available and you can read the FBS4 personalization data
2. Replace the ECU when **no FBS personalization data is available**

Here is the procedure from **scenario 1** explained briefly, each step will be expanded with more details later in a dedicated section:

1. Read the FBS personalization data from the original ECU, using OBDII connection in the vehicle, and save the file for later use!
2. Install a new or virgin unit in the vehicle.
3. Donor unit can now be virginized if not in virgin state.
4. Personalize with the already saved FBS data from the original unit - here you will need direct CAN Connection. (Blue CAN Wires)
5. The vehicle should start normally, there is no need to "Activate" the unit, as it gets activated automatically after 100 ignition cycles, while it operates normally in the meantime.

N.B. ALL virgin or new modules can be personalized with no restrictions!

Here is the procedure from **scenario 2** briefly explained, each step will be expanded with more details later in a dedicated section:

1. Install a new or virgin unit in the vehicle.
2. Donor unit can now be virginized if not in virgin state or new.
3. Personalize the unit by OBDII

Supported units when NO PREVIOUSLY PERSONALIZATION DATA IS AVAILABLE:

- EDC17 Bosch units
- MED17 Bosch units
- MRD1/MRG1 units
- MED41

4.1.1 ECU replacement WITHOUT previously saved personalization data (scenario 1):

Step 1: You need to be able to read the original unit's data. The procedure is executed in the vehicle by OBDII in most cases, however, certain units require **specific connections** described later in this user manual. Original ECU needs to be in place > open the ECU selection of the FBS4 manager, and press "Info" to establish connection to the unit, once the unit is read, press the "Save" button. This would read the required FBS4 personalization data from the ECU and let you save it to a file located on your computer.

Step 2: Install the replacement ECU in the vehicle.

If you are using a new or a virgin unit you can proceed to Step 4

Step 3: If you are working with a used donor unit, you will have to set it to virgin state.

To do that, click the "Info" button to read the unit and check its' unit status. Press the "Virgin" button to set the unit to virgin state. Procedure is executed via OBDII in most of the cases, but there are units that are not covered via OBDII, and you would have to go and do it on bench, there is dedicated procedure with all details explained.

Step 4: You would now have to press "Personalize" button, which would ask you to upload the file, previously saved from the original ECU. Procedure is executed via OBDII and direct CAN Connection (Blue CAN wires) Once connection is established, a new screen will come up, make sure you select "standard" option!

Once done, you can press the "Info" button and check if the unit is personalized.

The vehicle should start normally, there is no need to "Activate" the unit, as it gets activated automatically after 100 ignition cycles, while it operates normally in the meantime.

Step 5: Last step to complete the procedure is to write the VIN of the vehicle into the unit by pressing the "VIN" button, and a pop-up window will appear where you need to write the correct VIN to the unit

4.1.2 ECU replacement WITHOUT previously saved personalization data (scenario 2):

Step 1: Install the replacement ECU in the vehicle.

If you are using a new or a virgin unit you can proceed to Step 3

Step 2: If you are working with a used donor unit, you will have to set it to virgin state.

To do that, click the “Info” button to read the unit and check its’ unit status. Press the “Virgin” button to set the unit to virgin state. Procedure is executed via OBDII in most of the cases, but there are units that are not covered via OBDII, and you would have to go and do it on bench, there is dedicated procedure with all details explained.

Step 3: You would now have to press “Personalize” button, which would ask you to upload the file, previously saved from the original ECU. Here you have to **“cancel” the upload** as the original unit is missing or not available for reading. Procedure is executed via OBDII. Once connection is established, a new screen will come up, make sure you select “standard” option!

Once done, you can press the “Info” button and check if the unit is personalized.

The vehicle should start normally, there is no need to “Activate” the unit, as it gets activated automatically after 100 ignition cycles, while it operates normally in the meantime.

Step 4: Last step to complete the procedure is to write the VIN of the vehicle into the unit by pressing the “VIN” button, and a pop-up window will appear where you need to write the correct VIN to the unit

MN034 license required!

Supported units when NO PREVIOUSLY PERSONALIZATION DATA IS AVAILABLE:

- MED177
- MED1775
- MED40
- CR40
- CR41
- CR42
- CR43
- CR60LS
- CR61

4.1.3 MRG1/MRD1 replacement WITHOUT previously saved personalization data

Preparation:

When no original unit is not available, or completely damaged and not possible to read, you would need to do the following:

1. Connect to the vehicle via OBDII
2. Open the Mercedes FBS4 software and select Electronic Ignition Switch (EIS) press "Info"
3. Press "Save" to save personalization data file (EIS4 data file) to a location on your PC

Now set up the donor unit on bench, using ZN151 DS Box and CB030

1. Open the Mercedes FBS4 software and select ECU
 2. Press "Info" button to establish connection
 3. Set the unit to "Virgin" state through the dedicated button.
 4. **IMPORTANT:** At this stage you need to set the VIN of the vehicle to the donor ECU
 5. Once the VIN is set proceed to next step.
 6. Press "Personalize" and select the file with the saved EIS4 data from the EIS
 7. Once complete, software would ask you to turn IGN OFF and ON to finalize the procedure
- N.B. Unit activation happens automatically after 100 ignition cycles.

4.2 Connections:

We are able to work with the following connections in general:

In the vehicle:

- AVDI + CB106 OBDII Cable
- AVDI + CB106 OBDII Cable + CB012 - Direct CAN-BUS Connection Cable Set (needle connectors to internal CAN)
- AVDI + [ZN051 DS-Box](#) + CB106 OBDII Cable (+Can connectors to 3-11 of the DS Box and needle connectors to internal CAN) does not work for vehicles with EZS of the w213/W907/W177 types - in this case personalization is executed with the use of CB012 for CAN connection

Bench Connections:

- AVDI + [ZN051 DS Box](#) + CB401 (from the ZN051 set)
- AVDI + [ZN051 DS Box](#) + CB403 DS-Box Extended Cable Set for direct connection with various Automotive/Truck modules on Bench work
- AVDI + [ZN051 DS Box](#) + [CB030](#) Mercedes-Benz MD1/MG1 ECU connection cable for FBS4 Manager

CRR1 (SID307) and CRR1+ (SID310) – Done completely by OBDII

MRG1 and MRD1 bench connection - using [CB030](#) (with or without [ZN051 DS Box](#)) - details in the [CB030](#) dedicated section 4.3 of this user manual.

CRR2 (MD1CS006) - bench connection using DS Box and CB401

MED41 (MED17.7.7) - bench connection using DS Box and CB401

VGS4NAG2 - ABProg programmer!

DSM - ABProg programmer!

4.3 Virginization procedure:

If you have a donor unit that is not new, you need to make it virgin.

You can do that as follows:

- In the vehicle after step 2 of the replacement procedure
- On bench, at any point before installing the unit in the vehicle for personalization purpose.

4.3.1 Virginization in the vehicle by OBDII:

1. Install the donor (personalized) unit and click the “Info” button to read the unit and check its’ unit status.
2. Press the “Virgin” button to set the unit to virgin state.
3. Procedure is executed via OBDII in most of the cases, but there are units that are not covered via OBDII, and you would have to go and do it on bench.

Supported units:

MED17, EDC17, SID310, Delphi-CRD3 ECUs, (CR40, CR41, CR42, CR43, CR6, CR60, CR61, MED40, MED41, MED177, MED1773, MED1775, CRR1, CRR1+, CRD3, CRD3S2).

4.3.2 Virginization on bench:

You can set a unit into virgin state, using bench connection, and get it ready for personalization.

For that, you can use the following set-up options:

[ZN074](#) set recommended to provide power supply to the [ZN051 DS Box](#)

List of modules that **require more specific** bench connection for virginization

- MED41, MED41AMG - AVDI + [ZN051 DS Box](#) + CB403 DS Box Extended Cable Set - in specific cases
- MRD1, MRD1NFZ (produced up to 2021) AVDI + [ZN051 DS Box](#) + [CB030](#) Mercedes-Benz MD1/MG1 ECU connection cable for FBS4 Manager (EP003 license is also required)
- MRG1, MRG1AMG, MRG1AMGR4 (produced up to 2021) - AVDI + [ZN051 DS Box](#) + [CB030](#) Mercedes-Benz MD1/MG1 ECU connection cable for FBS4 Manager (EP003 license is also required) CRR2 MD1CS006 (produced up to 2021) - EP003 license is also required
- For the rest of the modules you can use AVDI + [ZN051 DS Box](#) + CB401

Connection diagrams for each module are available later in this user manual.

Once you have made the proper connections and have powered up the whole set-up, execute the following steps:

1. Open the Mercedes FBS4 Manager software
 2. Select the ECU option in the software
 3. Press the “Info” button to establish connection and read the unit’s information
 4. Press the “Save” button to read the FBS4 personalization data and save it to a file for a back-up
 5. Press the “Virgin” button to set the unit to a virgin state – so that is ready for personalization
- NB! Please press the “Info” button again to make sure the unit is properly set to “Virgin state”

4.4 Read FBS4 Personalization Data

Personalization data can be read in the vehicle or on bench.

4.4.1 Read FBS4 Personalization Data by OBDII

Reading personalization data by OBDII is available for the following units:

- MED17
- EDC17
- SID310
- Delphi- CRD3 ECUs, (CR40, CR41, CR42, CR43, CR6, CR60, CR61, MED40, MED41, MED177, MED1773, MED1775, CRR1, CRR1+, CRD3, CRD3S2).
- All MRD1, MRG1, MRG2, CRR2, EMS71 (no restrictions in production year!)

4.4.2 Read FBS4 Personalization Data on bench

You can find the connection diagrams for bench reading in the next section.

4.5 VIN Exchange

There are a few specifics with VIN exchange in Mercedes FBS4 vehicles.

VIN exchange can be executed in the vehicle via OBDII, or on bench. If the procedure would not go through, you would need a ZN051 DS Box connection to be able to update the VIN of the unit.

When performing personalization without previously saved FBS data, you would have to set the VIN of the unit before the actual personalization, in other words, the personalization procedure starts with setting the VIN of the vehicle to the donor unit. Normally, VIN is set after the personalization. In case you use the procedure with no personalization data, it would not actually go through, if the VIN of the donor unit is not the VIN of the vehicle.

4.6 ECU BENCH DIAGRAMS:

CB403 PIN OUT:

- 1 - pink - "IGN"
- 2 - yellow and yellow/white - "B+" (on both wires)
- 3 - red/blue - "K-LINE 1"
- 4 - purple - "BOOT 2"
- 5 - white - "BOOT 1"
- 6 - green - "T2"
- 7 - brown - "T1"
- 8 - red - "CAN H"
- 9 - green/white - "T3"
- 10 - green/brown - "T4"
- 11 - black - "GND"
- 12 - gray - "GND"
- 13 - yellow/brown - "B+ PERMANENT"
- 14 - blue - "CAN L"
- 15 - grey/pink - "K-LINE 7"

CB401 DB15 cable Legend:

- Power - Yellow (B+)
- IGN - Orange (IGN)
- GND - Black (GND)
- CAN HI - Red (CAN6)
- CAN LOW - Blue (CAN14)
- T1 - Brown (T1)
- T2 - Green (T2)
- Boot - White

Connection diagrams on the next page
Colors are dedicated to the CB401 cable.

MED40 BOSCH
 MED17.7.1 TC1797 V1
 MED17.7.3 TC1797
 MED17.7.3.1 TC1797 MED177
 MED17.7.5 TC1793 MED177
 MED177AMG
 MED177V6LA

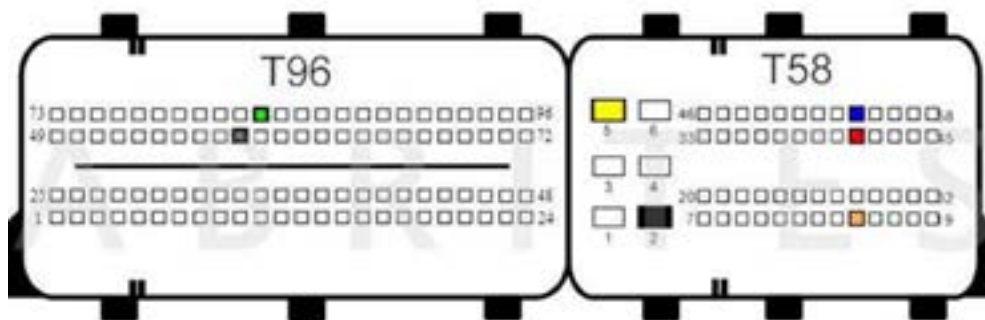

T96 PIN 83 – PWM
 T96 PIN 58 – PWM
 T58 PIN 2 – GND-
 T58 PIN 5 – 12V+
 T58 PIN 15 – IGN
 T58 PIN 41 – CAN-H
 T58 PIN 54 – CAN-L

MED17.7.1 TC1797 V2
 MED17.7.2 TC1797
 MED40AMG

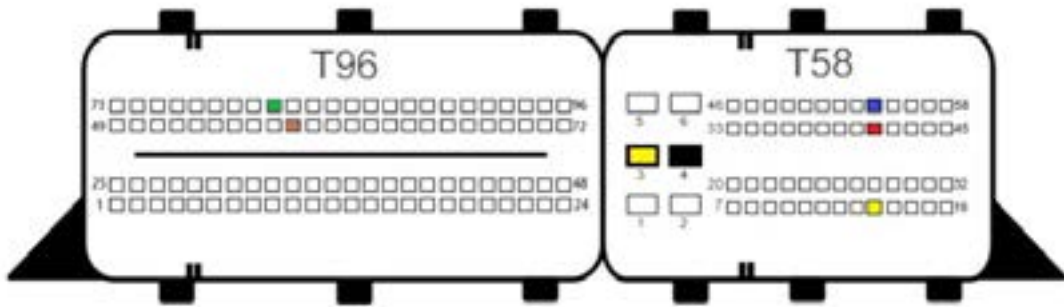

T96 PIN 81 – PWM
 T96 PIN 58 – PWM

T58 PIN 3 – 12V+ GND-
 T58 PIN 4 – GND-
 T58 PIN 15 – IGN
 T58 PIN 41 – CAN-H
 T58 PIN 54 – CAN-L

MED17.7.8 TC1797 MED177

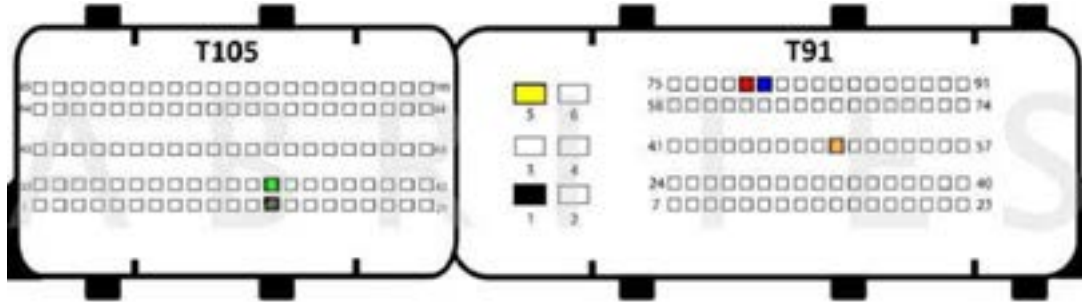

T105 PIN 13 - PWM

T105 PIN 34 - PWM

T91 PIN 1 - GND

T91 PIN 5 - B+

T91 PIN 50 - IGN

T91 PIN 79 - CAN H

T91 PIN 80 - CAN L

CR61 (EDC17CP57) (BOSCH EDC17CP57 TC1793)

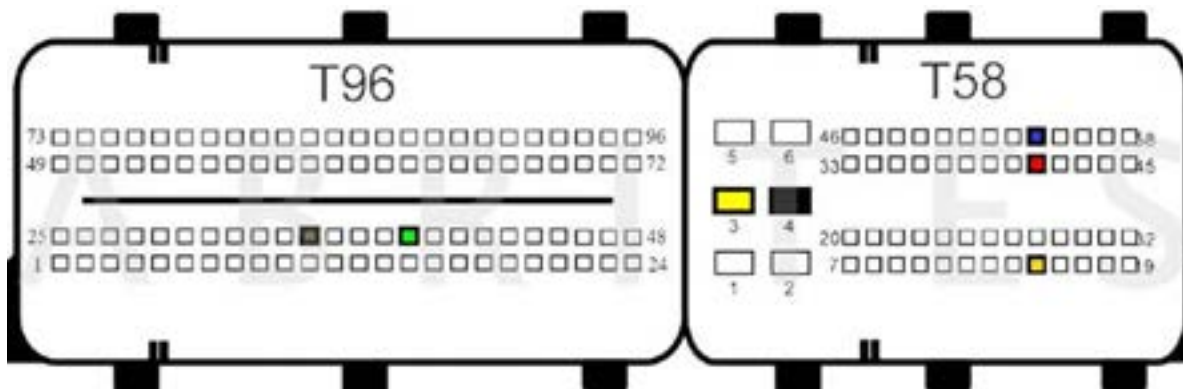

- T96 PIN 35 - PWM
- T96 PIN 39 - PWM
- T58 PIN 3 - 12V+
- T58 PIN 2 - GND-
- T58 PIN 15 - IGN
- T58 PIN 41 - CAN H
- T58 PIN 54 - CAN L

CR42 (EDC17CP46) BOSCH EDC17CP46 TC1797

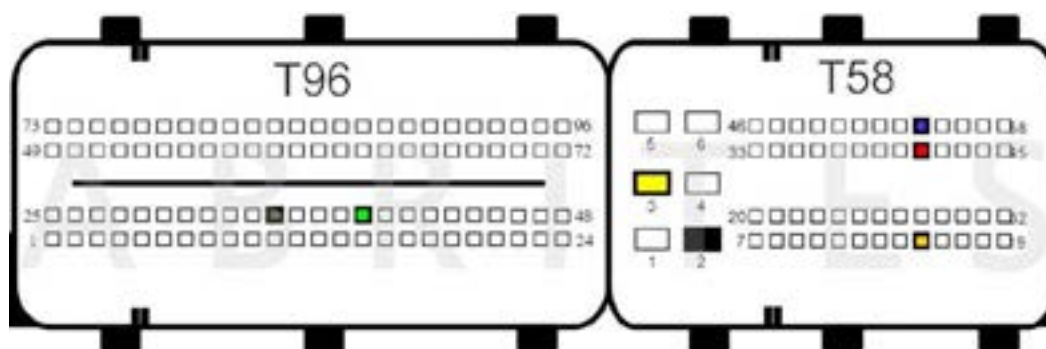

- T96 PIN 39 - PWM
- T96 PIN 35 - PWM
- T58 PIN 3 - 12V+
- T58 PIN 2 - GND-
- T58 PIN 15 - IGN
- T58 PIN 41 - CAN H
- T58 PIN 54 - CAN L

CR6 (EDC17CP10) BOSCH EDC17CP10 TC1796

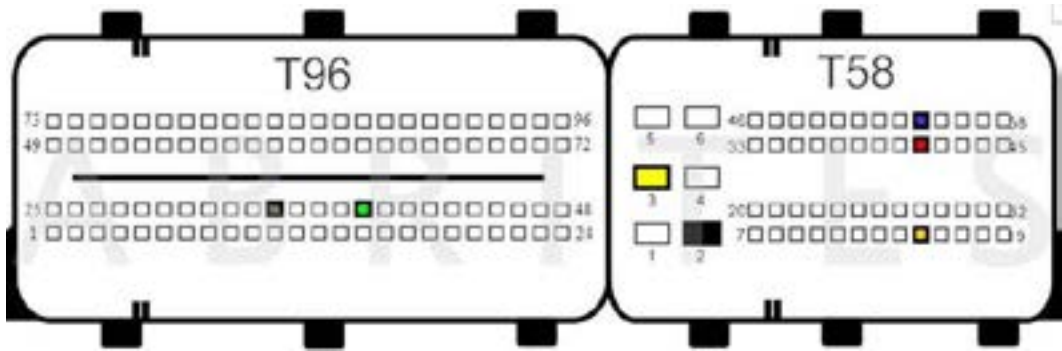

T96 PIN 39 - PWM
 T96 PIN 35 - PWM

T58 PIN 3 - 12V+
 T58 PIN 2 - GND-
 T58 PIN 15 - IGN
 T58 PIN 41 - CAN H
 T58 PIN 54 - CAN L

CR41 (EDC17C66)
 CR41R (EDC17C66)

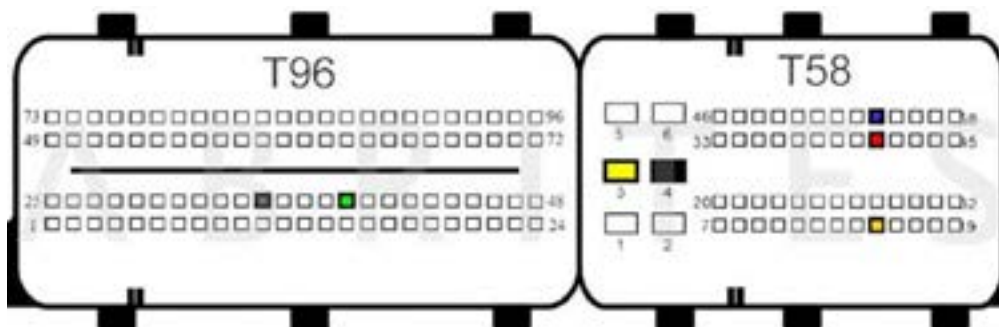

T58 Pin 3 - 12V
 T58 Pin 4 - GND
 T58 Pin 15 - IGN
 T58 Pin 41 - CAN H
 T58 Pin 54 - CAN L

T96 Pin 35 - PWM
 T96 Pin 39 - PWM

CR40 (EDC17C43)

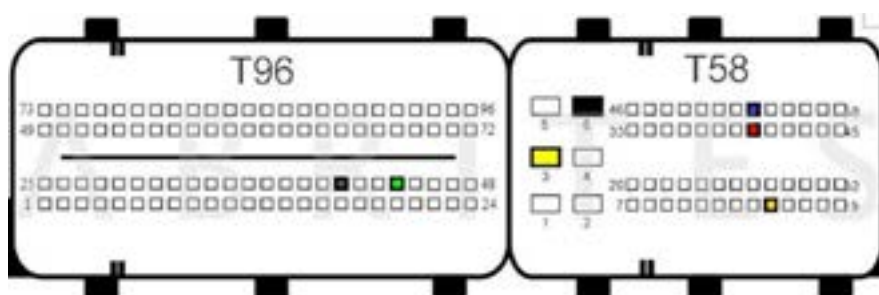

T58 PIN 3 - 12V+
 T58 PIN 6 - GND-
 T58 PIN 15 - IGN
 T58 PIN 40 - CAN H
 T58 PIN 53 - CAN L

T96 PIN 41 - PWM
 T96 PIN 44 - PWM

CR43 (EDC17CP60)

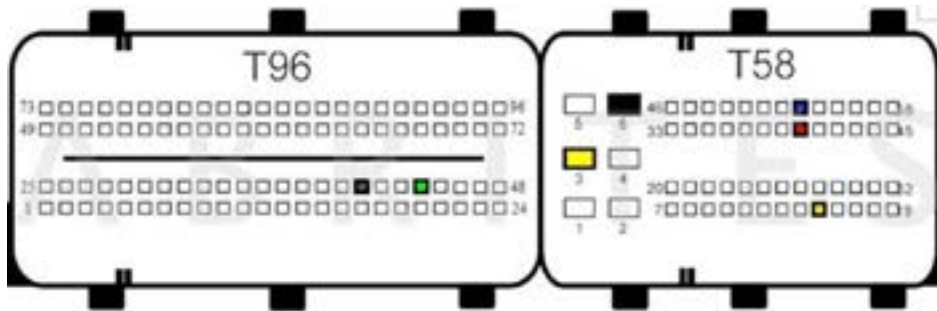

T58 PIN 5 - 12V+
T58 PIN 4 - GND-
T58 PIN 15 - IGN
T58 PIN 16 - 12V
T58 PIN 41 -CAN H
T58 PIN 54 -CAN L

T96 PIN 38 - PWM
T96 PIN 89 - PWM

MED41 (MED17.7.7) V1 - CB403 Recommended

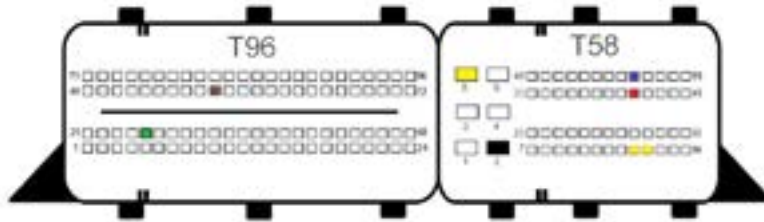

MED41 (MED17.7.7) V2 - CB403 Recommended

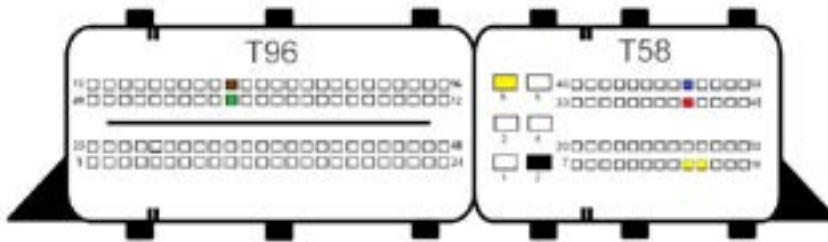

CR61_470 V1 (EDC17CP57) - CB403 Recommended

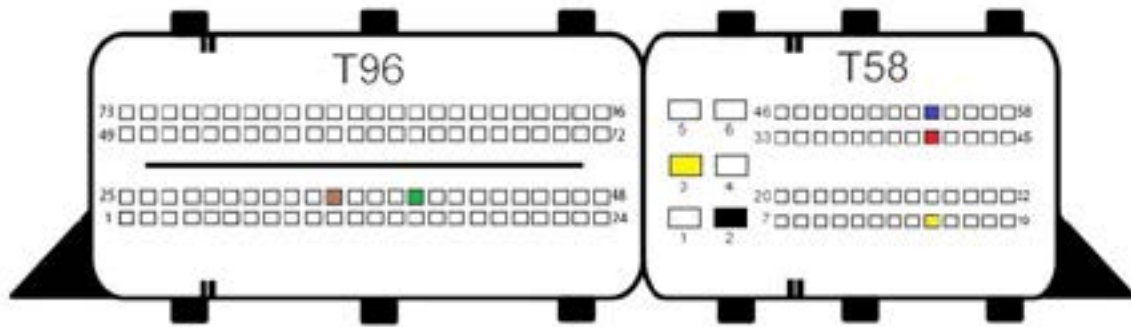

T96 PIN 35 - PWM

T96 PIN 39 - PWM

T58 PIN 2 - GND

T58 PIN 3 - B+ 12V

T58 PIN 15 - B+ 12V

T58 PIN 41 - CAN H

CR61_470 V2 (EDC17CP57) - CB403 Recommended

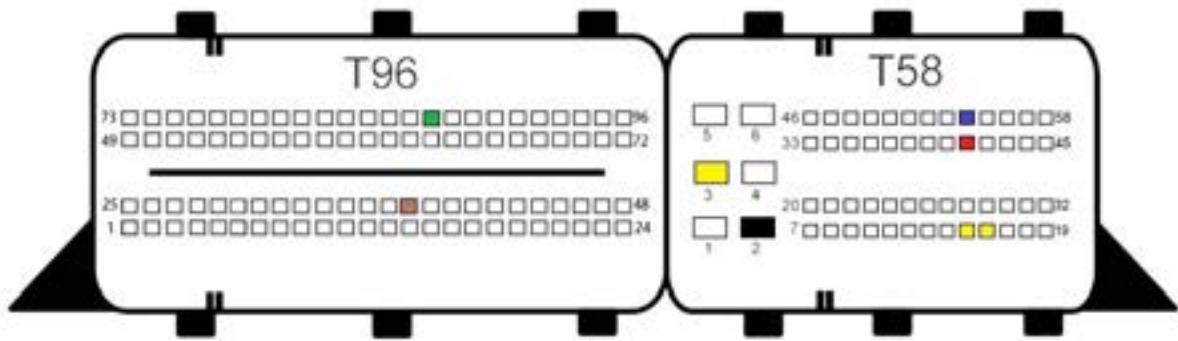

- T96 PIN 38 - PWM
- T96 PIN 87 - PWM
- T58 PIN 2 - GND
- T58 PIN 3 - B+ 12V
- T58 PIN 15 - B+ 12V
- T58 PIN 16 - B+ 12V
- T58 PIN 41 - CAN H
- T58 PIN 54 - CAN L
- MED40 (MED17.7.1)

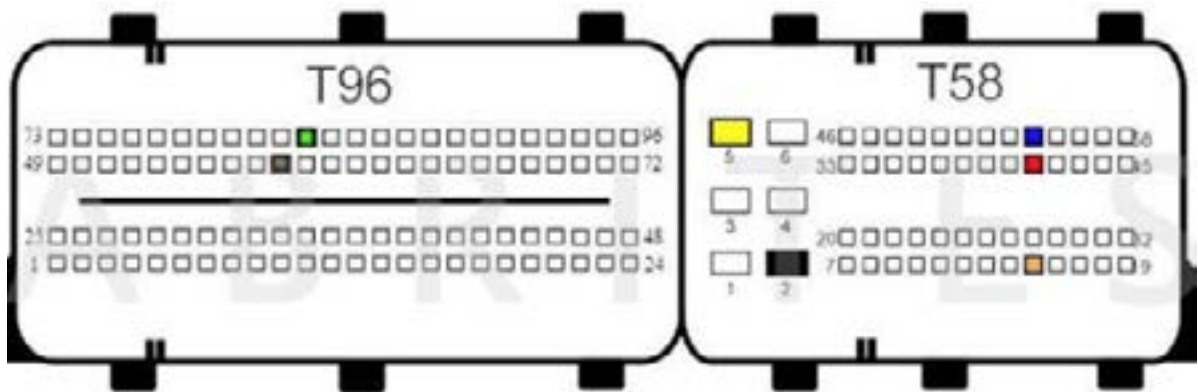

- T96 PIN 58 - PWM
- T96 PIN 83 - PWM
- T58 PIN 2 - GND
- T58 PIN 5 - B+ 12V
- T58 PIN 15 - IGN
- T58 PIN 41 - CAN H
- T58 PIN 54 - CAN L

MED40 (MED17.7.2)
 MED17.7.1 V2

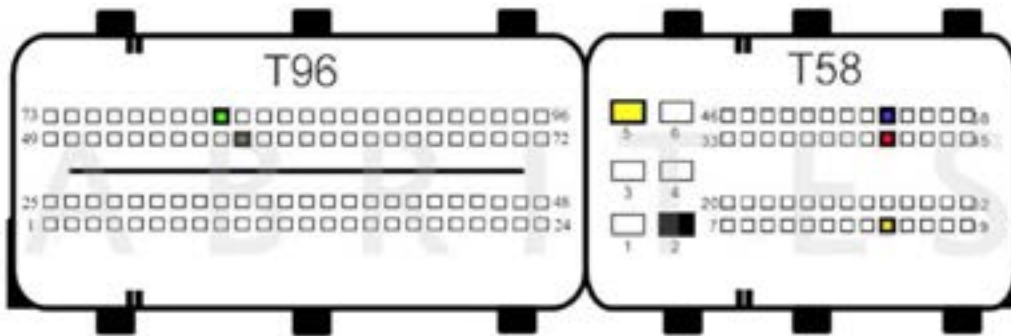

- T96 PIN 81 - PWM
- T96 PIN 58 - PWM
- T58 PIN 2 - GND
- T58 PIN 5 - B+ 12V
- T58 PIN 15 - IGN
- T58 PIN 41 - CAN H
- T58 PIN 54 - CAN L

CRR2 MD1CS006 TC298TP V1

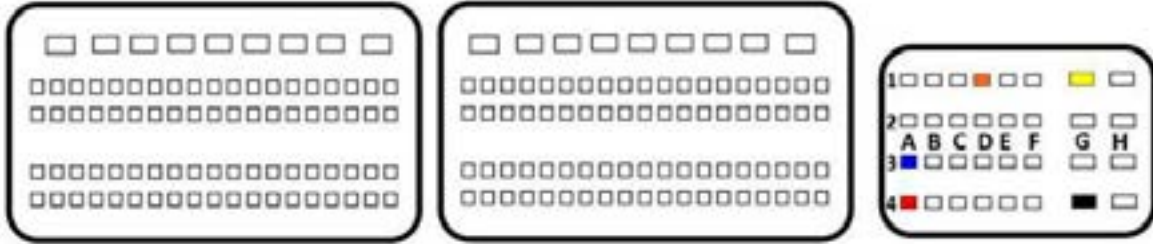

CRR2 MD1CS006 TC298TP V1

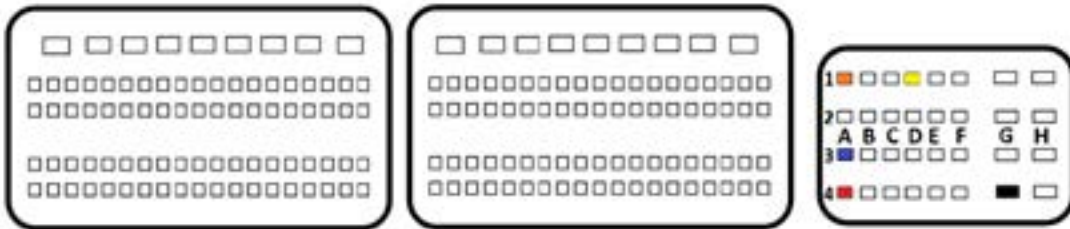

MRG1 (including 2021+) BOSCH MG1CP002 SPC577 - [CB030](#) strongly recommended!
CB030 has dedicated connector for MG1/MRG1 ECUs
Please check the next section for more details

MRD1 (including 2021+) BOSCH MD1CP002 SPC577 - [CB030](#) strongly recommended!
CB030 has dedicated connector for MD1/MRD1 ECUs
Please check the next section for more details



4.7 MRD1/MRG1 ECUs - CB030 - Mercedes-Benz MD/MG ECU connection cable

The [CB030](#) cable is intended for bench connection with the Engine Control Units from BOSCH types MD1 and MG1 (MRD1, MRG1) in Mercedes-Benz vehicles to:

- Read and save FBS data
- Set the unit to virgin state
- Personalize with data from file (which you can read and save)
- Personalize **without** previously saved FBS data
- Change VIN

IMPORTANT: Units produced after 2021 are locked! You are able to personalize brand new units, not ordered for the vehicle from a dealership.

Supported Units:

BOSCH MD1 and MG1 Engine Control Units

Connection:

Connect [CB030](#) to AVDI and ZN051 DS Box - connect DB25 connector and DB15 connector of CB030 to DS-BOX. Power supply should be provided to the ZN051's dedicated slots. ZN051 DS Box is connected to AVDI via CB402.

[ZN074](#) can be used for providing power supply in both cases.

The CB030 has two identical connectors with different pin outs and are labeled for MG1 and MD1 ECUs..

N.B. To avoid damage or malfunction to the ECU or your AVDI, make sure you use the correct type of connector for the ECU you are working with!

5. TCU Replacement

Transmission Control Unit section of the FBS4 Manager has the following functionalities:

- Read and save FBS data
- Set the unit to virgin state
- Personalize with data from file (which you can read and save)
- Personalize **without** existing personalization data
- Change VIN
- Update the software versions of the donor module in accordance with the original ones

This will allow you to perform a complete TCU exchange, so that the vehicle can start and run properly. One of the many benefits of these procedures is that when adapting transmissions, we do not clone them, we only transfer the necessary Immo-related data (FBS Data), keeping donor's calibration values.

Supported units:

- VGS4-NAG2 7G-Tronic
- VGS-NAG3 9G-Tronic
- VGS-FDCT/VGS2-FDCT
- 8-DCT
- GT-DCT

For details on how to work on each of the Transmission Control Units, please check the dedicated section of this user manual

Procedures may differ depending on your active licenses. Please consult Abrites team for details.

After the transmission is personalized, it is important to ensure that the software versions of the original transmission match those of the donor TCU.

The "Program" button allows you to update the donor TCU's software versions to align with the original transmission versions.

You have two options: either load your own files(.cff) by browsing your PC, if available, or use our server to program the TCU with the correct software versions.

If you are replacing a TCU (only the electronics) it is important to save a back up of the configuration of the original TCU (Utilities > Save all Config data).

If you are replacing the whole transmission unit (electronics and mechanical part) then you would have to use the configuration that is on the donor TCU.

5.1 VGS4 NAG2 7G-Tronic

Procedures are very specific depending on your active licenses. If you have all relevant Abrites Mercedes software licenses VGS4-NAG2 replacement procedure is as follows:

5.1.1 VGS4-NAG2 Personalization with Previously saved data

Original unit in the vehicle.

Connections: In the vehicle by OBDII

Read and save VGS4-NAG2 FBS data procedure:

1. Connect to the vehicle
2. Open the Mercedes FBS4 software
3. Select TCU
4. Press "Info" button to establish connection
5. Press "Save" button to read and save the FBS data

Once the reading is complete and the file is saved, please make sure you also make a back-up of the Configuration data of the unit as follows: TCU > "Utilities"> "Save All Config Data. This data together with the FBS4 data will let you personalize a unit.

Personalization procedure:

1. Install donor unit in the vehicle
 2. Open the Mercedes FBS4 software and select TCU
 3. Press "Info" button to establish connection
 4. Press "Personalize" and select the file with the saved FBS data from the original TCU.
 5. Software would ask you to turn IGN OFF and ON to finalize the procedure
 6. Program the configuration data by pressing the "Utilities" then "Program All Config Data" and use the files saved from the original TCU.
 7. Set the VIN
 8. Use the "Program" button in case you need to align software versions.
- N.B. Unit activation happens automatically after 100 ignition cycles.

5.1.2 VGS4-NAG2 Personalization WITHOUT previously saved data

Connections: In the vehicle by OBDII and internal CAN (diagnostic CAN) - CB012 Direct CAN-BUS/LIN-BUS Connection Cable Set is recommended!

Personalization procedure:

1. Install donor TCU unit in the vehicle
 2. Press "Info" button to establish connection and check status of the unit
 3. Now select "Electronic Ignition Switch" and press "Info"
 4. Press "Save" to save personalization data file (EIS4 data file)
 5. Save the file on your PC for later use.
 6. Select TCU
 7. Press "Info" button to establish connection
 8. Press "Personalize" and select the file with the saved EIS4 data from the EIS (make sure file type is correct)
 9. Once complete, software would ask you to turn IGN OFF and ON to finalize the procedure
 10. Set the VIN
- N.B. Unit activation happens automatically after 100 ignition cycles.

5.1.3 VGS4-NAG2 Legacy Procedures

Procedures below are replaced with the MN039 license

If you do not have the latest software licenses, or you will have to do some mechanical work. Unit needs to be opened, and ABProg programmer is used, SET088 is recommended, with that, you can do the following:

- Read FBS4 data from VGS4 NAG2 modules
- Set VGS4 NAG2 modules to virgin state - ZN030 ABProg programmer or SET088 required
- Write FBS4 personalization data to the TCU

If MN034 license is active, personalization procedure can be executed via OBDII and internal CAN connection. Personalization without previously saved FBS data is also available!

SET088 has ABProg programmer, and it is recommended when working with the VGS4-0-NAG2 TCUs.

We are aware of 2 types or generations of VGS4NAG2 units, which have different type of connectors and PCBs: VGS4-0 NAG2 (Type 1), and VGS4-500 NAG2 (Type 2)

NOTE: Once you cut open the TCU, remove the jelly very gently only where you need to connect (or solder), to avoid damage to the unit!

After you complete the task, make sure you close the TCU pcb well, and glue the cover so no oil can enter and damage the unit!

NB! Make sure your ABPRrog programmer is updated with the latest firmware.

Important: In some cases the TCU will remain in a state that does not let you operate with it, once the "Info" button is pressed, power consumption will drastically drop. In this situation you have to turn OFF the power supply and turn it back ON right away. Power consumption will remain below 0.2A (0.16-0.19) and this is the state when the TCU will respond normally to the software.

The **SET088** contains all the necessary hardware tools to open and connect to the 7G-Tronic VGS4-0 NAG2 in FBS4 vehicles. This set allows you to open the transmission control unit and connect to the required points without soldering. The set in combination with the MN035 license offers a great way to reuse second-hand modules in FBS4 vehicles, enabling you to reset the donor module, and adapt it into the vehicle.

Functionalities:

- Open the transmission control unit type 7G-Tronic VGS4-0 NAG2
- Connect to the correct points on the module's PCB using a custom designated adapter

Supported vehicles:

All vehicles with VGS4-0 NAG2 7G-Tronic TCU of the FBS4/DAS4 generation Mercedes-Benz

Contents of the set:

- ZN088 - 7G-Tronic VGS4-0 NAG2 FBS4 Solder-Free Connection Adapter
- CB088 - 7G-Tronic VGS2/3/4-0 NAG2 FBS3/FBS4 Direct CAN BUS Connection Cable
- ZN045 - Abprog
- ZN090 - JTAG Adapter For ABPROG
- MT001 - Custom drill head
- CB101 - AVDI extension cable for ABPROG

N.B: ZN090 has 2 LEDs, 1 indicates that connection with the TCU is established (target) and the other indicates the connection to ABPROG is established. You need to have them both ON, so that you can proceed to working with the TCU.



Type 1: VGS4-0-NAG2

Read FBS data is available in 2 ways:

1. By OBDII (with active MN032)
2. By ABProg (with active MN035)

Read and save VGS4-0-NAG2 FBS data procedure:

1. Connect to the unit (connections explained below)
2. Open the Mercedes FBS4 software
3. Select TCU
4. Press "Info" button to establish connection
5. Press "Save" button to read and save the FBS data

Once the reading is complete and the file is saved, please make sure you also make a back-up of the Configuration data of the unit as follows: TCU > "Utilities"> "Save All Config Data. This data together with the FBS4 data will let you personalize a unit.

Additionally, write down the software version of the original TCU and it's VIN in a text file as a backup.

Connections:

- In the vehicle by OBDII and internal CAN (diagnostic CAN)
- On bench with the use of [CB088 - 7G-Tronic Direct CAN BUS Connection Cable](#) and 12v power supply - ZN074 set is recommended.
- By ABProg - you can either solder to the PCB or use the SET088 solder free solution, and the procedure requires a bit of mechanical work too, check connections [HERE](#)

Set the unit to virgin state (required if you are using a second hand donor unit)

This procedure is executed only on bench and with the use of an ABProg programmer. SET088 is recommended and MN035 license

Procedure:

1. Connect to the TCU - please check connections [HERE](#)
1. Open the Mercedes FBS4 Software and select TCU
2. Press "Info" button to check the status of the unit and establish connection
3. Press "Virgin" button to set the unit to virgin state
4. Once complete, the unit will be ready for personalization

Personalization available in 2 ways:

1. By OBDII (with active MN034)
2. By ABProg (with active MN035)

Here is how to execute the procedure

1. Connect to the unit (connections explained below)
2. Open the Mercedes FBS4 software and select TCU
3. Press "Info" button to establish connection
4. Press "Personalize" and select the file with the saved FBS data from the original TCU
5. Program the configuration data by pressing the "Utilities" then "Program All Config Data" and use the files saved from the original TCU.
6. Set the VIN
7. Use the "Program" button in case you need to align software versions

Connections:

- In the vehicle by OBDII and internal CAN (diagnostic CAN)
- On bench with the use of [CB088 - 7G-Tronic Direct CAN BUS Connection Cable](#) and 12v power supply - ZN074 set is recommended.
- By ABProg - you can either solder to the PCB or use the SET088 solder free solution, and the procedure requires a bit of mechanical work too, check connections [HERE](#)

Watch video [HERE](#)

VGS4-0-NAG2 Connection ABProg or SET088

1. Cut open the TCU - We suggest you use the dedicated tool in the SET88, which has a template, or check picture below.
2. Connect to the specific PCB PINs
Option 1: by soldering wires to the specific points on the TCU (diagrams below)
Option 2: with the needle set adapter ZN088
3. Connect to the ABProg programmer
Option 1: DIY connector explained in the dedicated section
Option 2: ribbon cable from the SET88 is connected to the ZN088 and to the ZN090, then ZN090 is connected to ABProg
4. Connect ABProg programmer to AVDI directly or with CB101
5. Connect AVDI to the Laptop via CB104 USB Cable
6. Connect to the TCU connector
Option 1: DIY DB25 connector for VGS4NAG2
Option 2: CB088 or the dedicated cable from the CB011 set.
7. Power up the set with 12v DC
We suggest the power adapter from the ZN074 set and connect it to the CB088 cable from the SET88.
8. Start the software

Important: Once you cut open the TCU, remove the jelly very gently only where you need to solder, to avoid damage!

N.B! Please note that there are some variations of these units, and if the unit is not readable when the needles of the ZN088 are connected, you will have to switch the position to the other side.



Examples of where yo cut open the unit and a connection by soldering.

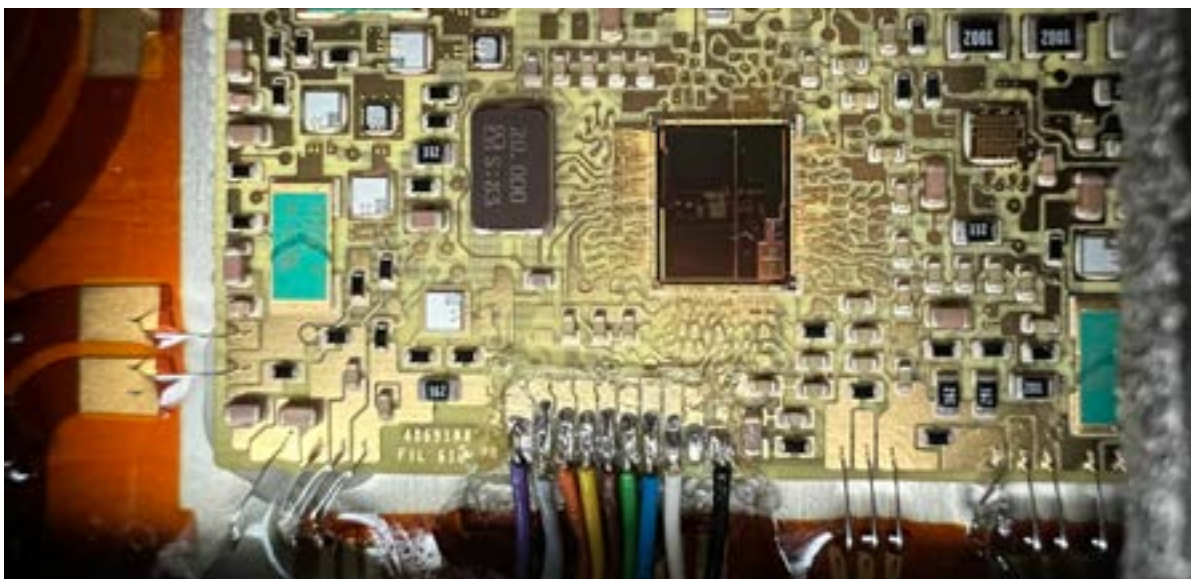

DIY DB25 connector - Here is how you can make your DIY connector with a DB25 and the corresponding wires to solder to the TCUs PCB for VGS4-0 NAG2 PCB TYPE 1

DB25 connector is connected to the [ZN030 ABProg programmer](#).

It is very important to pay attention to the specifications on the wired for this connection. Also, it is important that you use isolated wires for that connection.

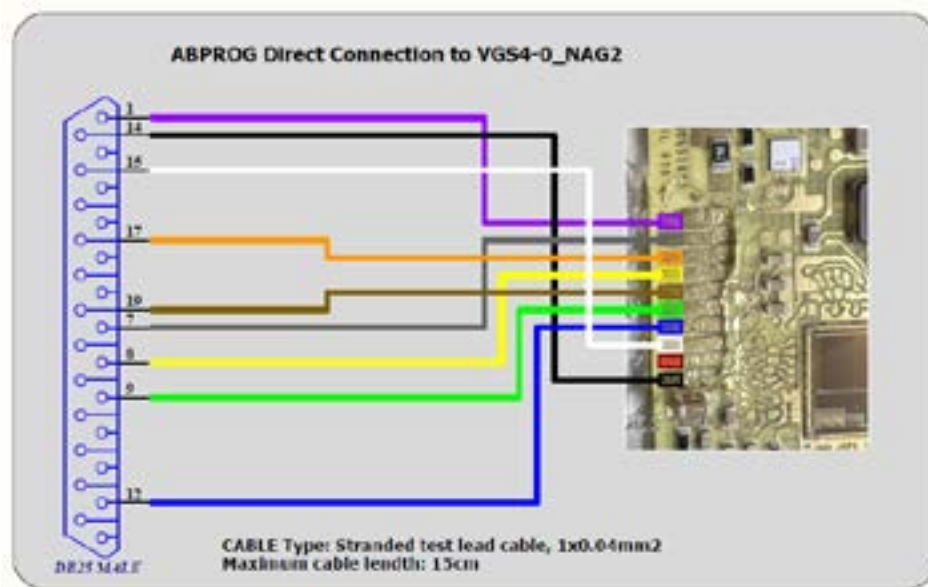

Here is how to connect to the unit with CB088 or a DIY connection:

DIY connection for VGS4-0-NAG2 and DB25 to AVDI
PIN 1 TCU Connector CAN H > PIN 7 DB 25 (to AVDI)
PIN 2 TCU Connector CAN L > PIN 15 DB25 (to AVDI)
PIN 4 TCU Connector 12V+ > PIN 17 DB25 (to AVDI)
PIN 5 TCU Connector GND > PIN 5 DB25 (to AVDI)
Resistor R120 Ohm between CAN H and CAN L
Power supply 13.6V power supply is required!

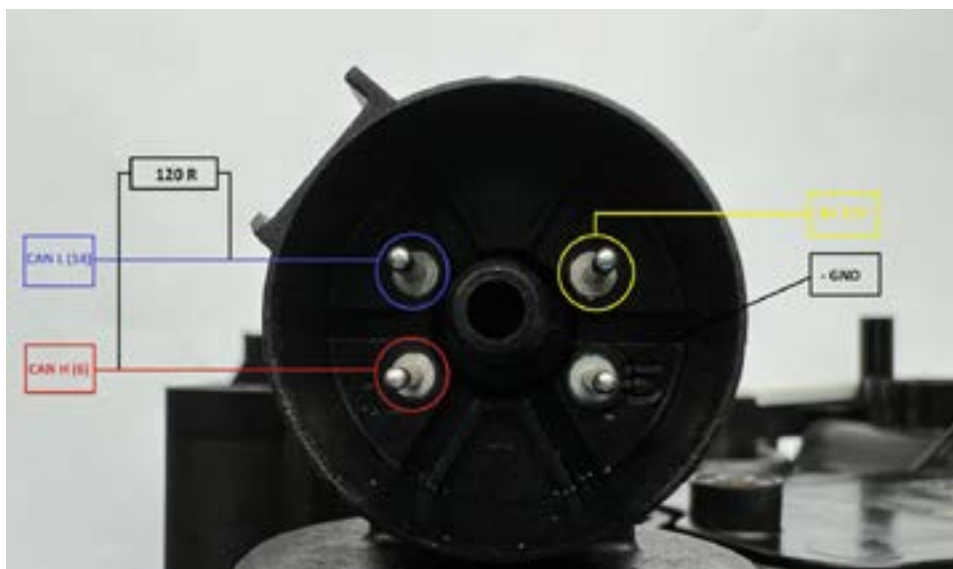

Type 2: VGS4-500-NAG2

Read FBS data is available in 2 ways:

1. By OBDII (with active MN032)
2. By ABProg (with active MN035)

Read and save VGS4-500-NAG2 FBS data procedure:

1. Connect to the unit (connections explained below)
2. Open the Mercedes FBS4 software
3. Select TCU
4. Press "Info" button to establish connection
5. Press "Save" button to read and save the FBS data

Once the reading is complete and the file is saved, please make sure you also make a back-up of the Configuration data of the unit as follows: TCU > "Utilities"> "Save All Config Data. This data together with the FBS4 data will let you personalize a unit.

Additionally, write down the software version of the original TCU and it's VIN in a text file as a backup.

Connections:

- In the vehicle by OBDII and internal CAN (diagnostic CAN)
- On bench with the use of ZN151 or ZN051 and CB403 (diagram available below)
- By ABProg - procedure requires a bit of mechanical work too, check connections [HERE](#)

Set the unit to virgin state (required if you are using a second hand donor unit)

This procedure is executed only on bench and with the use of an ABProg programmer.

Procedure:

1. Connect to the TCU - please check connections [HERE](#)
1. Open the Mercedes FBS4 Software and select TCU
2. Press "Info" button to check the status of the unit and establish connection
3. Press "Virgin" button to set the unit to virgin state
4. Once complete, the unit will be ready for personalization

Personalization available in 2 ways:

1. By OBDII (with active MN034)
2. By ABProg (with active MN035)

Here is how to execute the procedure

1. Connect to the unit (connections explained below)
2. Open the Mercedes FBS4 software and select TCU
3. Press "Info" button to establish connection
4. Press "Personalize" and select the file with the saved FBS data from the original TCU
5. Program the configuration data by pressing the "Utilities" then "Program All Config Data" and use the files saved from the original TCU.
6. Set the VIN
7. Use the "Program" button in case you need to align software versions

Connections:

- In the vehicle by OBDII and internal CAN (diagnostic CAN)
- On bench with the use of ZN151 or ZN051 and CB403 (diagram available below)
- By ABProg - please check connections [HERE](#)

Watch video [HERE](#)

Here is how to make a DIY connector with a DB25 that connects to AVDI as follows:

TCU connector CAN L > PIN 15 DB25 (to AVDI)

TCU connector CAN H > PIN 7 DB 25 (to AVDI)

TCU Connector B+ 12V > PIN 17 DB25 (to AVDI)

TCU connector GND- > PIN 5 DB25 (to AVDI)

Resistor R120 Ohm between CAN H and CAN L

Power supply 12V DC to the connector



DIY DB25 connector for VGS4-500-NAG2

Here is how you can make your DIY connector with a DB25 and the corresponding wires to solder to the TCUs PCB for VGS4NAG2 PCB (VGS4-500-NAG2) TYPE 2

DB25 connector is connected to the [ZN030 ABProg programmer](#).

It is very important to pay attention to the specifications on the wires for this connection. Also, it is important that you use isolated wires for that connection.

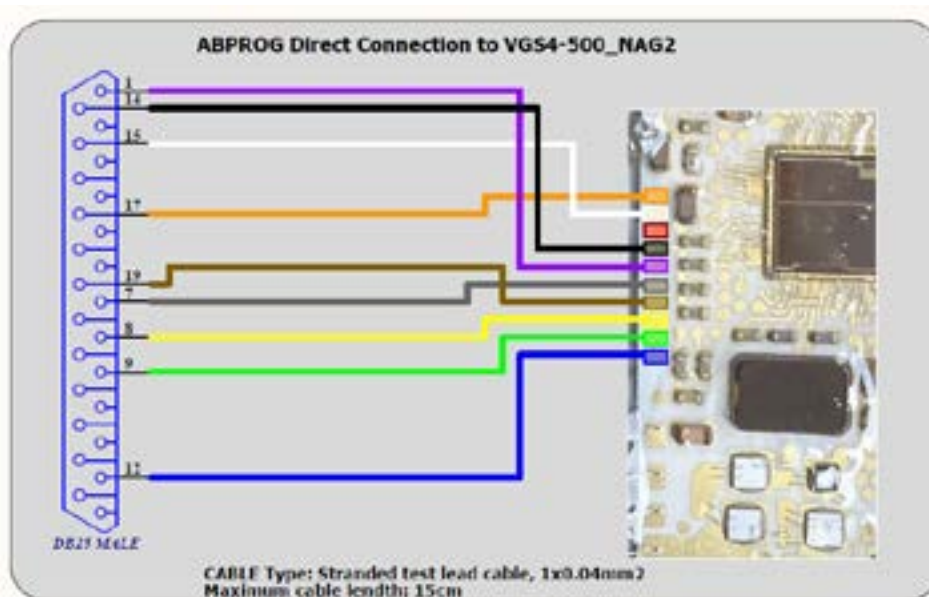

Here is where you have to cut open the plastic cover of the TCU in order to get access to the PCB for ABProg connection.



5.2 VGSNAG3 9G-tronic

Procedures are very specific depending on your active licenses. In case of questions, please contact Abrites team for information.

5.2.1 VGSNAG3 Personalization with previously saved data

Procedure has the following requirements to start:

Original unit in the vehicle.

In the vehicle by OBDII for reading

Read and save VGS-NAG3 FBS data procedure:

1. Connect to the vehicle - In the vehicle by OBDII for reading
2. Open the Mercedes FBS4 software
3. Select TCU
4. Press "Info" button to establish connection
5. Press "Save" button to read and save the FBS data

Once the reading is complete and the file is saved, please make sure you also make a back-up of the Configuration data of the unit as follows: TCU > "Utilities"> "Save All Config Data. This data together with the FBS4 data will let you personalize a unit.

Personalization procedure:

1. Set up the donor unit on bench, using ZN151 DS Box and CB403 - DS-BOX Extended Cable Set for direct connection. (Connection information available at the end of this section)
2. Open the Mercedes FBS4 software and select TCU
3. Press "Info" button to establish connection
4. Set the unit to "Virgin" state through the dedicated button.

(From this step on, or if you already have a virgin unit, you can proceed working in the vehicle via OBDII and internal CAN connection)

5. Press "Personalize" and select the file with the saved FBS data from the original TCU.
6. Software would ask you to turn IGN OFF and ON to finalize the procedure
7. Program the configuration data by pressing the "Utilities" then "Program All Config Data" and use the files saved from the original TCU.
8. Set the VIN
9. Use the "Program" button in case you need to align software versions.

N.B. Unit activation happens automatically after 100 ignition cycles.

5.2.2 VGSNAG3 Personalization WITHOUT previously saved data

Preparation:

When no original unit is not available, or completely damaged and not possible to read, you would need to do the following:

1. Connect to the vehicle via OBDII
2. Open the Mercedes FBS4 software and select Electronic Ignition Switch (EIS) press "Info"
3. Press "Save" to save personalization data file (EIS4 data file) to a location on your PC

Now set up the donor unit on bench, using ZN151 DS Box and CB403 - DS-BOX Extended Cable Set for direct connection. Connection information also on the next page

1. Open the Mercedes FBS4 software and select TCU
 2. Press "Info" button to establish connection
 3. Set the unit to "Virgin" state through the dedicated button.
 4. **IMPORTANT:** At this stage you need to set the VIN of the vehicle to the donor TCU
 5. Once the VIN is set proceed to next step.
 6. Press "Personalize" and select the file with the saved EIS4 data from the EIS
 7. Once complete, software would ask you to turn IGN OFF and ON to finalize the procedure
- N.B. Unit activation happens automatically after 100 ignition cycles.

Connection for:

- Read the unit (also available in the vehicle)
- Virgin procedure ONLY done on bench
- Personalization with previously saved data (it could also be done in the vehicle with OBDII and direct CAN Connection and active MN034)
- Personalization without previously saved data only done on bench

To establish the proper connections follow the steps:

- Connect CB403 to the TCUs connector, according to the diagram
- Connect AVDI to ZN151 DS Box with the CB403 cable
- Connect CB403 to ZN151 DS Box and provide power supply to the ZN151 DS Box

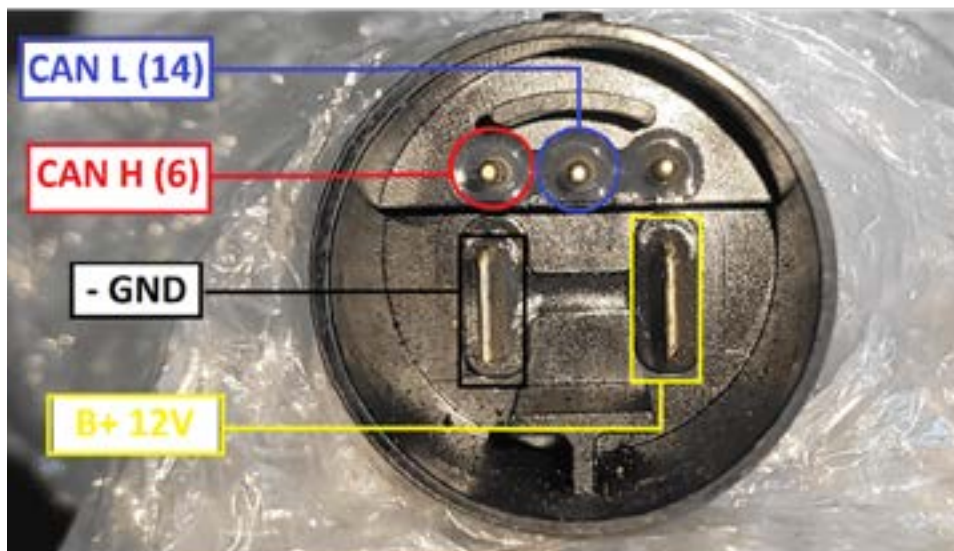

5.3 VGS2-DCT Mercedes & VGSNAG2-FDCT

Connection to this TCU can be established with the [ZN051 DS Box](#) and the [CB403 - DS-BOX Extended Cable Set for direct connection](#)

The connector of the FDCT does not have a PIN for GND, so you have to connect the GND black connector cable anywhere on the metal body of the TCU (see picture below)

To establish the proper connections follow the steps:

- Connect CB403 to the TCUs connector, according to the diagram
- Connect AVDI to ZN151 DS Box with the CB402 cable
- Connect CB403 to ZN151 DS Box and provide power supply to the ZN051 DS Box

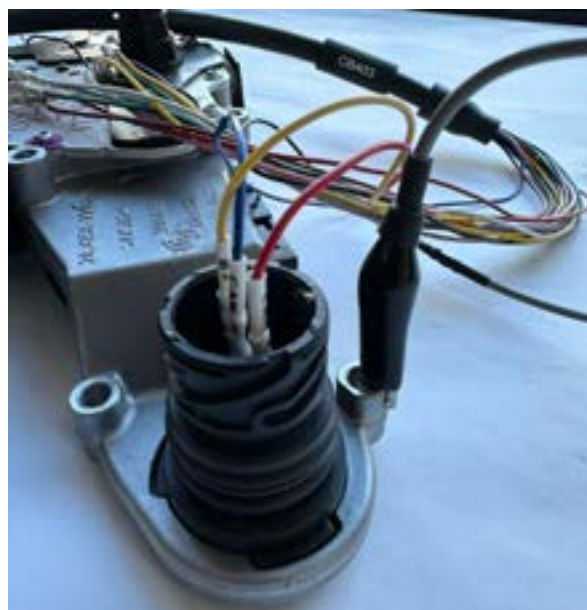
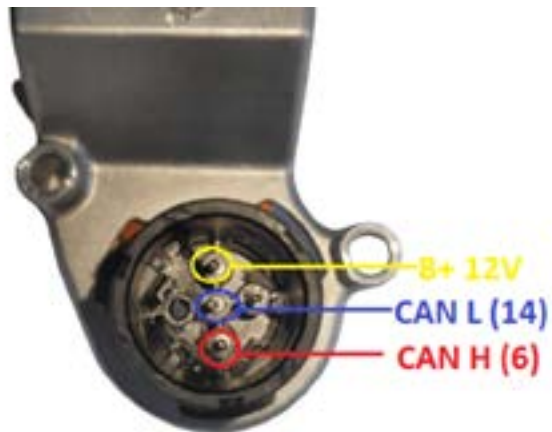

5.3.1 Personalization with previously saved data

Procedure has the following requirements to start:

Original unit in the vehicle.

In the vehicle by OBDII for reading

Read and save FBS data procedure:

1. Connect to the vehicle - In the vehicle by OBDII for reading
2. Open the Mercedes FBS4 software
3. Select TCU
4. Press "Info" button to establish connection
5. Press "Save" button to read and save the FBS data

Once the reading is complete and the file is saved, please make sure you also make a back-up of the Configuration data of the unit as follows: TCU > "Utilities" > "Save All Config Data. This data together with the FBS4 data will let you personalize a unit.

Personalization procedure:

1. Set up the donor unit on bench, using ZN151 DS Box and CB403 - DS-BOX Extended Cable Set for direct connection. (Connection information available at the end of this section)
 2. Open the Mercedes FBS4 software and select TCU
 3. Press "Info" button to establish connection
 4. Set the unit to "Virgin" state through the dedicated button.
(From this step on, or if you already have a virgin unit, you can proceed working in the vehicle via OBDII and internal CAN connection)
 5. Press "Personalize" and select the file with the saved FBS data from the original TCU.
 6. Software would ask you to turn IGN OFF and ON to finalize the procedure
 7. Program the configuration data by pressing the "Utilities" then "Program All Config Data" and use the files saved from the original TCU.
 8. Set the VIN
 9. Use the "Program" button in case you need to align software versions.
- N.B. Unit activation happens automatically after 100 ignition cycles.

N.B. Procedures are very specific depending on your active licenses. In case of questions, please contact Abrites team for information.

6. DSM replacement

Direct Select Module (DSM/DSM222) section of the FBS4 Manager has the following functionalities:

- Read and save FBS data
- Set the unit to virgin state
- Personalize with data from file (which you can read and save)
- Personalize **without** existing personalization data
- Change VIN

All that lets you do a complete DSM exchange so that the vehicle can start and run properly.

6.1 Direct Select Module (DSM) replacement procedure

- Reading can be executed via OBDII, via CB034, or via ABProg and ZN086
- Virgin procedure can be executed via OBDII, via CB034, or via ABProg and ZN086
- Personalization with previously saved FBS Data can be executed OBDII and internal CAN connection with CB012, via CB034, or via ABProg and ZN086
- Personalization without previously saved FBS data can only be executed on bench with the use of ABProg and ZN086

6.1.1 Personalization with previously saved data

Procedure has the following requirements to start:

Original unit in the vehicle.

Connection by OBDII for reading (you can also read with CB034 or via ABProg - check legacy procedure)

Read and save FBS data procedure:

1. Connect to the vehicle - In the vehicle by OBDII for reading
2. Open the Mercedes FBS4 software
3. Select DSM
4. Press "Info" button to establish connection
5. Press "Save" button to read and save the FBS data

Personalization procedure:

1. Install the donor unit in the vehicle
2. Open the Mercedes FBS4 software and select DSM
3. Press "Info" button to establish connection
4. Set the unit to "Virgin" state through the dedicated button.
(You can proceed working in the vehicle via OBDII and internal CAN connection with CB012)
5. Press "Personalize" and select the file with the saved FBS data from the original DSM.
6. Software would ask you to turn IGN OFF and ON to finalize the procedure
7. Set the VIN

6.1.2 DSM Personalization without previously saved FBS data

Preparation:

When no original unit is available, or completely damaged and not possible to read, you would need to do the following:

1. Connect to the vehicle via OBDII
2. Open the Mercedes FBS4 software and select Electronic Ignition Switch (EIS) press "Info"
3. Press "Save" to save personalization data file (EIS4 data file) to a location on your PC

Now set up the donor unit on bench, using ZN030 ABProg programmer and ZN086, details available below.

1. Open the Mercedes FBS4 software and select DSM
 2. Press "Info" button to establish connection
 3. Set the unit to "Virgin" state through the dedicated button.
 4. **IMPORTANT:** At this stage you need to set the VIN of the vehicle to the donor DSM
 5. Once the VIN is set proceed to next step.
 6. Press "Personalize" and select the file with the saved EIS4 data from the EIS
 7. Once complete, software would ask you to turn IGN OFF and ON to finalize the procedure
- N.B. Unit activation happens automatically after 100 ignition cycles.

6.2 Connections

There are 2 ways you can directly connect to the DSM module:

1. CB034 - DSM/ISM Direct CAN BUS Connection Cable - this cable lets you connect directly to the DSM connector.
2. ABProg and ZN086

The ZN086 adapter is soldered onto four points on the PCB (one of which is the lifted pin) and then connected to the ABPROG > the ABPROG is connected to AVDI, and AVDI to your laptop.

Important: The PIN that needs lifting, is specific for each processor, and you need to find that information first. Since there are many variations, you will need to do your own research and get to the processor's data sheet. The PIN that needs lifting is the "RST" or reset PIN.

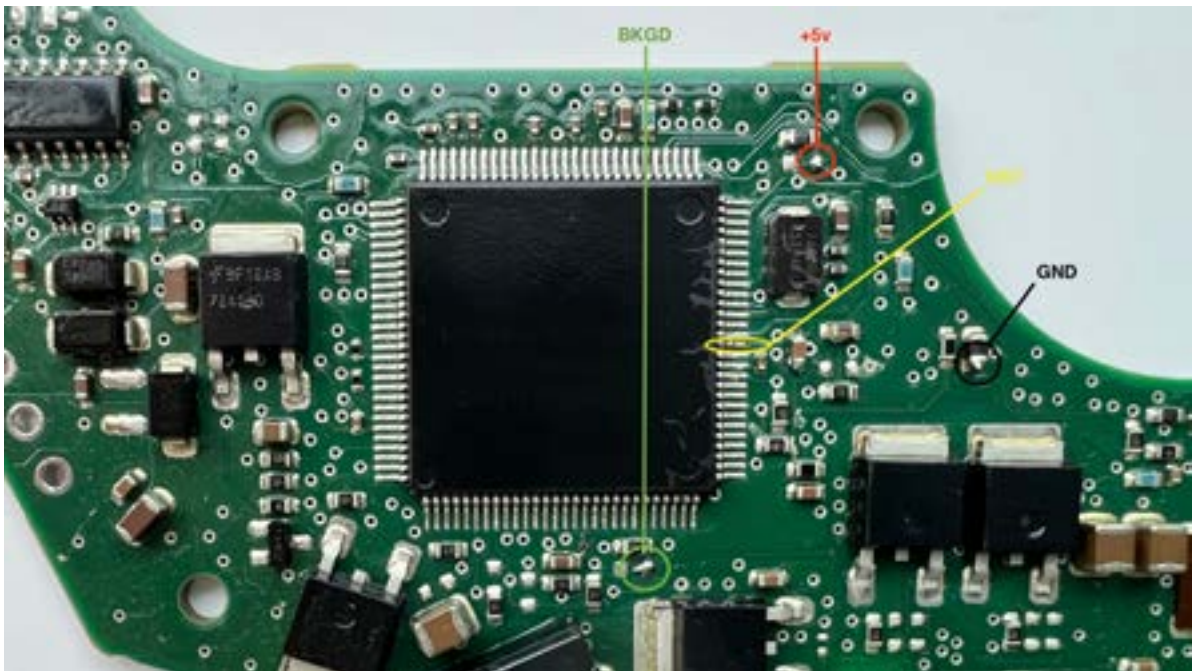

6.3 Legacy procedure for DSM

Once all the connections (described below) are done, you can open the FBS4 Manager > select the DSM > read the module.

Original DSM needs to be connected and you need to open the DSM selection of the FBS4 manager, and press the “**Save**” button. This would read the required data from the DSM and let you save it to a file located on your computer.

Next step is to connect the donor DSM and read the unit (by pressing “info”) and check if everything is in tact. FBS4 Manager > DSM Selection. After that you can proceed with making the unit virgin by pressing the “**Virgin**” button.

You would now have to press “**Personalize**” button, which would ask you to upload the file, previously saved from the original DSM. Once done, you can press the “info” button and check if the unit is personalized and activated. If everything is good, you would only have to do one more thing.

Last step to complete the procedure is to write the VIN of the vehicle into the unit by pressing the “**VIN**” button, and a pop-up window will appear where you need to write the correct VIN to the unit.

7. ESL (ELV) Repair

This functionality is dedicated to resolving a problem with the “ELV Component Fault” of all FBS4 vehicles equipped with an ESL (ELV), which is preventing the vehicle from being started and driven.

The ESL (ELV) module defects due to dirt, overuse or voltage spikes and sticks in its last position - “locked” or “unlocked” and the vehicle cannot be started.

The function will remove the error in the ESL (ELV) and unlock it, and allow the car to start.

N.B. To avoid this problem happening again in the future, some of the defective components in the ESL (ELV) should be repaired/exchanged.

The function is performed with a direct connection to the ESL (ELV) diagnostic line. It can be executed direct in the vehicle or on bench.

Required software license: MN033 – Mercedes-Benz FBS4 Vehicles Electronic Steering Lock Repair

7.1 Connections

Connection in the vehicle (using Distribution box):

1. Connect [ZN051 Distribution Box](#) between AVDI and CB100/CB106 OBD-II cable
2. Connect the CB100/CB106 OBD-II to the OBD-II port of the vehicle
3. Connect AVDI to PC through CB104 USB A-B cable
4. Use a needle from the ZN051 set to puncture the LIN (K-line) going to the ELV and connect to it (or to the LIN cable of the EZS/EIS (yellow/green))
5. Connect the needle to the K7 socket of the ZN051 Distribution box

Connection in the vehicle (using CB026):

1. Connect CB026 between AVDI and CB100/CB106 OBD-II cable
2. Connect the OBDII cable (CB100/CB106) to the OBD port of the vehicle
3. Connect AVDI to PC through CB104 USB A-B cable
4. Use the needle from CB026 and connect LIN of ESL (or LIN of EZS(yellow/green)) to the green wire of CB026

Connection on bench (using ZN051 Distribution box):

1. Connect ZN051 Distribution Box to AVDI
2. Connect AVDI to PC through CB104 USB A-B cable
3. Connect ZN051 distribution box to an external power supply using the B+ and GND sockets
4. Connect B+, GND and LIN of the ESL (ELV) to the B+, GND and K7 socket of the ZN051 Distribution box

Connection on bench (using CB026):

1. Connect CB026 to AVDI
2. Connect AVDI to PC through CB104 USB A-B cable
3. Connect 1A power supply to the power supply connector of CB026
4. Connect B+, GND, LIN of ESL to B+, GND, green wire of CB026

7.2 ESL (ELV) diagrams/pinouts for connection on bench.

Below you can see the 2 types of connectors and their pinouts:

Picture 1 - 3 PIN Connector

Picture 2 - 5 PIN Connector

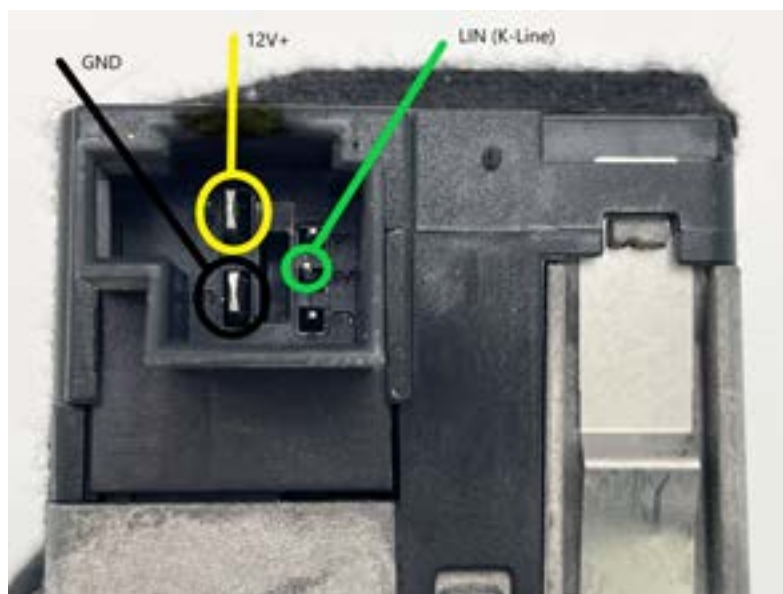
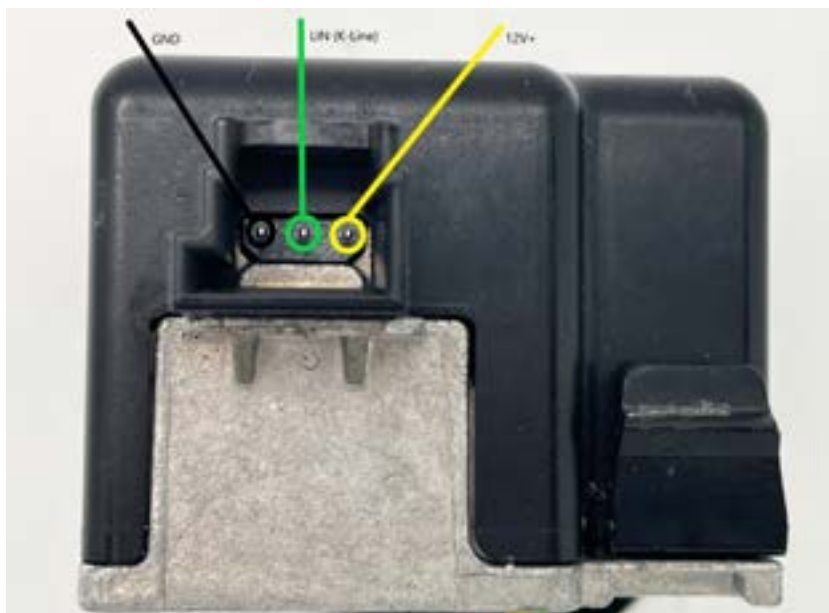

7.3 Procedure Execution

When the connection is established, please follow these steps to repair the ESL (ELV):

1. Open the Abrites Quick Start menu > Mercedes-Benz > FBS4
2. Select Steering Lock
3. Press the button "Info" and make sure you see the information of the Steering Lock, and the error is also displayed
4. Press the button "Repair" - at this point, the ESL (ELV) will be unlocked, and error will be removed from the ESL (ELV) memory.

After performing this procedure, you could start and drive the vehicle. We would suggest getting the vehicle in the workshop, cleaning and repairing the defective parts in the ESL (ELV).

Video 1: <https://www.youtube.com/watch?v=YSzF7eu7bTQ>

Video 2: <https://www.youtube.com/watch?v=7hXThRq1kHY>

8 More functionalities of the FBS4 Manger

EIS selection > info > gives the identification of the module and information is the unit is personalized, activated, and if the engine start is enabled

Car Key selection > info > identification of the unit, number of keys programmed to the vehicle

8.1 ECU Recovery procedure

In case you need to recover your Engine Control Unit you can follow these steps:

- Open FBS4 Manager
- Press Info to establish connection to the unit
- Check the status and proceed to programming if needed

To restore: be aware what you need to restore and press "Program"

- On the next screen select "Load file from server"
- A screen will pop-up, where you have to manually write the number of the software you need to update.

*For details, please check the dedicated video in AVDI Fan YouTube Page.

